

## Preface

The Atmel® SAM D21 Xplained Pro evaluation kit is a hardware platform to evaluate the ATSAM D21J18A microcontroller.

Supported by the Atmel Studio integrated development platform, the kit provides easy access to the features of the Atmel ATSAM D21J18A and explains how to integrate the device in a custom design.

The Xplained Pro MCU series evaluation kits include an on-board Embedded Debugger, and no external tools are necessary to program or debug the ATSAM D21J18A.

The Xplained Pro extension kits offers additional peripherals to extend the features of the board and ease the development of custom designs.

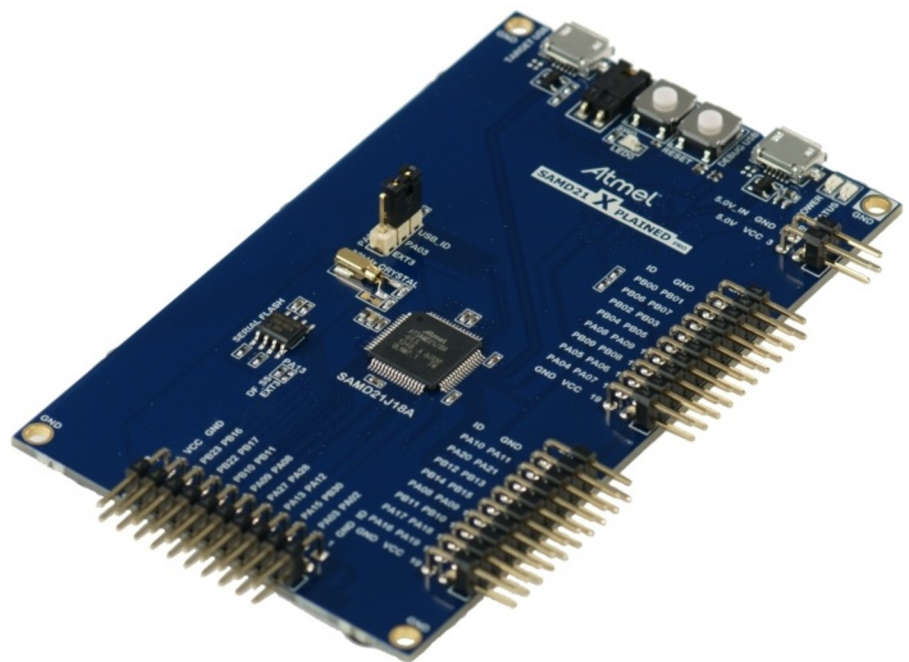

## Table of Contents

---

Preface.....	1
1. Introduction.....	3
1.1. Features.....	3
1.2. Kit Overview.....	3
2. Getting Started.....	5
2.1. Xplained Pro Quick Start.....	5
2.2. Design Documentation and Relevant Links.....	5
3. Xplained Pro.....	7
3.1. Embedded Debugger.....	7
3.2. Hardware Identification System.....	8
3.3. Power Sources.....	8
3.4. Xplained Pro Headers and Connectors.....	9
3.4.1. Xplained Pro Standard Extension Header.....	9
3.4.2. Xplained Pro Power Header.....	10
4. Hardware Users Guide.....	11
4.1. Connectors.....	11
4.1.1. Xplained Pro Standard Extension Headers.....	11
4.1.2. Current Measurement Header.....	13
4.2. Peripherals.....	14
4.2.1. Crystal.....	14
4.2.2. Mechanical Buttons.....	14
4.2.3. LED.....	14
4.2.4. USB.....	14
4.2.5. Serial Flash.....	15
4.3. Embedded Debugger Implementation.....	15
4.3.1. Serial Wire Debug.....	15
4.3.2. Virtual COM Port.....	15
4.3.3. Atmel Data Gateway Interface.....	15
5. Appendix.....	17
5.1. Getting Started with IAR.....	17
6. Hardware Revision and Known Issues.....	20
6.1. Identifying Product ID and Revision.....	20
6.2. Revision 2.....	20
7. Document Revision History.....	21
8. Evaluation Board/Kit Important Notice.....	22

# 1. Introduction

## 1.1. Features

- Atmel ATSAM D21 J18A microcontroller
- Embedded debugger (EDBG)
  - USB interface
  - Programming and debugging on board SAM D21 through Serial Wire Debug (SWD)
  - Virtual COM-port interface to target via UART
  - Atmel Data Gateway Interface (DGI) to target via SPI and TWI
  - Four GPIOs connected to target for code instrumentation
- Digital I/O
  - Two mechanical buttons (user and reset button)
  - One user LED
  - Three extension headers
- Three possible power sources
  - External power
  - Embedded debugger USB
  - Target USB
- 32kHz crystal
- USB interface, device and reduced host mode
- 8Mbit Serial Flash

## 1.2. Kit Overview

The Atmel SAM D21 Xplained Pro evaluation kit is a hardware platform to evaluate the Atmel ATSAM D21 J18A.

The kit offers a set of features that enables the ATSAM D21 J18A user to get started using the ATSAM D21 J18A peripherals right away and to get an understanding of how to integrate the device in their own design.

Figure 1-1. SAM D21 Xplained Pro Evaluation Kit Overview

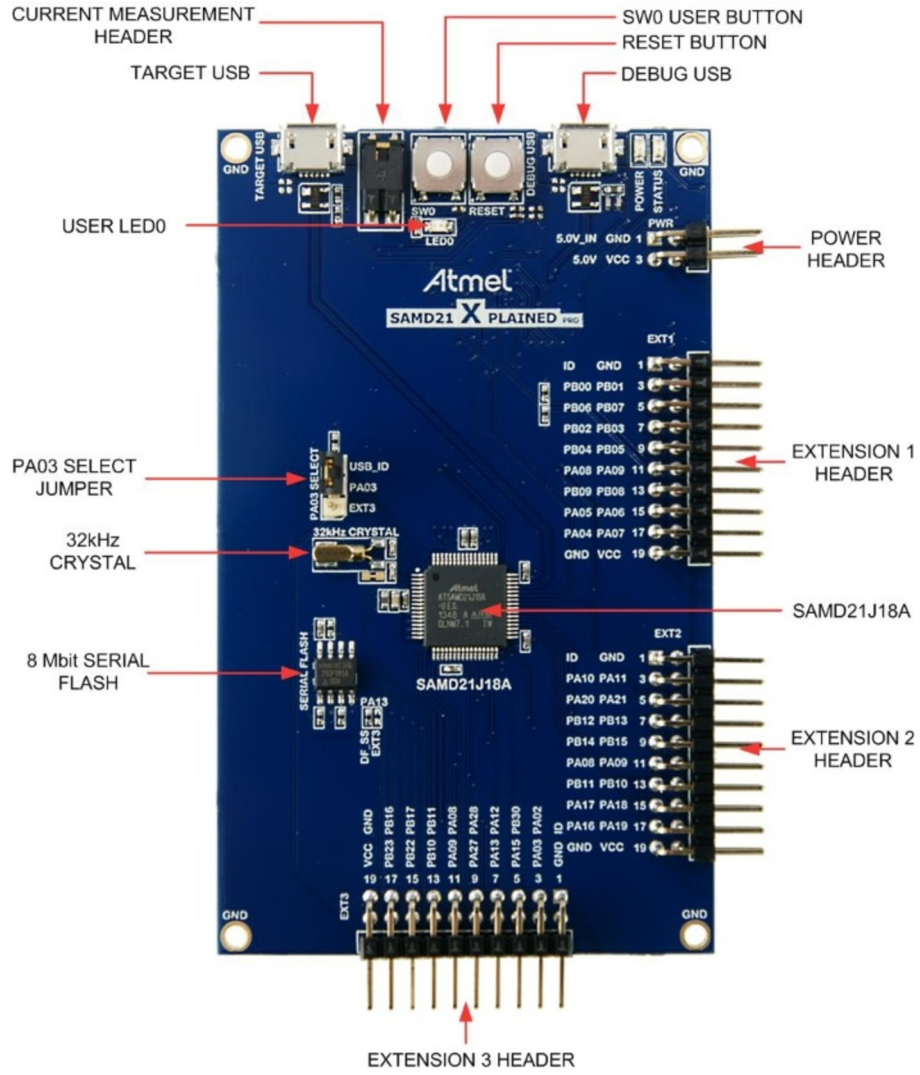

## 2. Getting Started

### 2.1. Xplained Pro Quick Start

Steps to start exploring the Atmel Xplained Pro platform:

1. Download [Atmel Studio](#).
2. Launch Atmel Studio.
3. Connect a USB cable (Standard-A to Micro-B or Micro-AB) between the PC and the DEBUG USB port on the kit.

When the Xplained Pro MCU kit is connected to your computer for the first time, the operating system will perform a driver software installation. The driver file supports both 32- and 64-bit versions of Microsoft® Windows® XP, Windows Vista®, Windows 7, Windows 8, Windows 10, and Windows Server 2012.

Once the Xplained Pro MCU board is powered the green power LED will be lit and Atmel Studio will auto detect which Xplained Pro MCU- and extension board(s) are connected. Atmel Studio will present relevant information like datasheets and kit documentation. The kit landing page in Atmel Studio also has the option to launch Atmel Software Framework (ASF) example applications for the kit. The SAM D21 device is programmed and debugged by the on-board Embedded Debugger and therefore no external programmer or debugger tool is needed.

### 2.2. Design Documentation and Relevant Links

The following list contains links to the most relevant documents and software for the SAM D21 Xplained Pro.

- [Xplained products](#) - Atmel Xplained evaluation kits are a series of easy-to-use evaluation kits for Atmel microcontrollers and other Atmel products. For low pin-count devices the Xplained Nano series provides a minimalistic solution with access to all I/O pins of the target microcontroller. Xplained Mini kits are for medium pin-count devices and adds Arduino Uno compatible header footprint and a prototyping area. Xplained Pro kits are for medium to high pin-count devices, they features advanced debugging and standardized extensions for peripheral functions. All these kits have on board programmers/debuggers which creates a set of low-cost boards for evaluation and demonstration of features and capabilities of different Atmel products.
- [Atmel Studio](#) - Free Atmel IDE for development of C/C++ and assembler code for Atmel microcontrollers.
- [Atmel sample store](#) - Atmel sample store where you can order samples of devices.
- [EDBG User Guide](#) - User guide containing more information about the on-board Embedded Debugger.
- [IAR Embedded Workbench® for ARM®](#) - This is a commercial C/C++ compiler that is available for ARM®. There is a 30 day evaluation version as well as a code size limited kick-start version available from their website. The code size limit is 16KB for devices with M0, M0+, and M1 cores and 32KB for devices with other cores.
- [Atmel QTouch® Library PTC](#) - QTouch Library for Atmel AVR® and ARM®-based microcontrollers.
- [Atmel QTouch® Composer](#) - Tool for developing capacitive buttons, sliders, and wheels applications.
- [Atmel Data Visualizer](#) - Atmel Data Visualizer is a program used for processing and visualizing data. Data Visualizer can receive data from various sources such as the Embedded Debugger Data Gateway Interface found on Xplained Pro boards and COM ports.

- [Design Documentation](#) - Package containing CAD source, schematics, BOM, assembly drawings, 3D plots, layer plots etc.
- [Hardware Users Guide in PDF format](#) - PDF version of this User Guide.
- [SAM D21 Xplained Pro on Atmel web page](#) - Atmel website link.

### 3. Xplained Pro

Xplained Pro is an evaluation platform that provides the full Atmel microcontroller experience. The platform consists of a series of Microcontroller (MCU) boards and extension boards, which are integrated with Atmel Studio, have Atmel Software Framework (ASF) drivers and demo code, support data streaming, and more. Xplained Pro MCU boards support a wide range of Xplained Pro extension boards, which are connected through a set of standardized headers and connectors. Each extension board has an identification (ID) chip to uniquely identify which boards are connected to an Xplained Pro MCU board. This information is used to present relevant user guides, application notes, datasheets, and example code through Atmel Studio.

#### 3.1. Embedded Debugger

The SAM D21 Xplained Pro contains the Atmel Embedded Debugger (EDBG) for on-board debugging. The EDBG is a composite USB device of three interfaces; a debugger, Virtual COM Port, and a Data Gateway Interface (DGI).

Together with Atmel Studio, the EDBG debugger interface can program and debug the ATSAMD21J18A. On SAM D21 Xplained Pro, the SWD interface is connected between the EDBG and the ATSAMD21J18A.

The Virtual COM Port is connected to a UART on the ATSAMD21J18A and provides an easy way to communicate with the target application through terminal software. It offers variable baud rate, parity, and stop bit settings. Note that the settings on the ATSAMD21J18A must match the settings given in the terminal software.



**Info:** The virtual COM port in the EDBG requires the terminal software to set the data terminal ready (DTR) signal to enable the UART pins connected to the ATSAMD21J18A. If the DTR signal is not enabled the UART pins on the EDBG is kept in high-z (tristate) rendering the COM port unusable. The DTR signal is set automatically by some terminal software, but it may have to be manually enabled in your terminal.

The DGI consists of several physical interfaces for communication with the host computer. Communication over the interfaces is bidirectional. It can be used to send events and values from the ATSAMD21J18A or as a generic printf-style data channel. Traffic over the interfaces can be timestamped on the EDBG for more accurate tracing of events. Note that timestamping imposes an overhead that reduces maximal throughput. [Atmel Data Visualizer](#) is used to send and receive data through DGI.

The EDBG controls two LEDs on SAM D21 Xplained Pro; a power LED and a status LED. The table below shows how the LEDs are controlled in different operation modes.

**Table 3-1. EDBG LED Control**

Operation mode	Power LED	Status LED
Normal operation	Power LED is lit when power is applied to the board.	Activity indicator, LED flashes when any communication happens to the EDBG.
Bootloader mode (idle)	The power LED and the status LED blinks simultaneously.	
Bootloader mode (firmware upgrade)	The power LED and the status LED blinks in an alternating pattern.	

For further documentation on the EDBG, see the [EDBG User Guide](#).

### 3.2. Hardware Identification System

All Xplained Pro compatible extension boards have an Atmel ATSHA204 CryptoAuthentication™ chip mounted. This chip contains information that identifies the extension with its name and some extra data. When an Xplained Pro extension is connected to an Xplained Pro MCU board the information is read and sent to Atmel Studio. The Atmel Kits extension, installed with Atmel Studio, will give relevant information, code examples, and links to relevant documents. The table below shows the data fields stored in the ID chip with example content.

**Table 3-2. Xplained Pro ID Chip Content**

Data field	Data type	Example content
Manufacturer	ASCII string	Atmel\0'
Product Name	ASCII string	Segment LCD1 Xplained Pro\0'
Product Revision	ASCII string	02\0'
Product Serial Number	ASCII string	1774020200000010\0'
Minimum Voltage [mV]	uint16_t	3000
Maximum Voltage [mV]	uint16_t	3600
Maximum Current [mA]	uint16_t	30

### 3.3. Power Sources

The SAM D21 Xplained Pro kit can be powered by several power sources as listed in the table below.

**Table 3-3. Power Sources for SAM D21 Xplained Pro**

Power input	Voltage requirements	Current requirements	Connector marking
External power	5V $\pm$ 2% ( $\pm$ 100mV) for USB host operation. 4.3V to 5.5V if USB host operation is not required.	Recommended minimum is 1A to be able to provide enough current for connected USB devices and the board itself. Recommended maximum is 2A due to the input protection maximum current specification.	PWR
Embedded debugger USB	4.4V to 5.25V (according to USB spec.)	500mA (according to USB spec.)	DEBUG USB
Target USB	4.4V to 5.25V (according to USB spec.)	500mA (according to USB spec.)	TARGET USB

The kit will automatically detect which power sources are available and choose which one to use according to the following priority:



1. External power.
2. Embedded Debugger USB.
3. Target USB.



**Info:** External power is required when 500mA from a USB connector is not enough to power the board with possible extension boards. A connected USB device in a USB host application might easily exceed this limit.

## 3.4. Xplained Pro Headers and Connectors

### 3.4.1. Xplained Pro Standard Extension Header

All Xplained Pro kits have one or more dual row, 20-pin, 100mil extension header. Xplained Pro MCU boards have male headers, while Xplained Pro extensions have their female counterparts. Note that all pins are not always connected. All connected pins follow the defined pin-out description in the table below.

The extension headers can be used to connect a variety of Xplained Pro extensions to Xplained Pro MCU boards or to access the pins of the target MCU on Xplained Pro MCU boards directly.

**Table 3-4. Xplained Pro Standard Extension Header**

Pin number	Name	Description
1	ID	Communication line to the ID chip on an extension board
2	GND	Ground
3	ADC(+)	Analog to digital converter, alternatively positive part of differential ADC
4	ADC(-)	Analog to digital converter, alternatively negative part of differential ADC
5	GPIO1	General purpose I/O
6	GPIO2	General purpose I/O
7	PWM(+)	Pulse width modulation, alternatively positive part of differential PWM
8	PWM(-)	Pulse width modulation, alternatively negative part of differential PWM
9	IRQ/GPIO	Interrupt request line and/or general purpose I/O
10	SPI_SS_B/ GPIO	Slave select for SPI and/or general purpose I/O
11	I <sup>2</sup> C_SDA	Data line for I <sup>2</sup> C interface. Always implemented, bus type.
12	I <sup>2</sup> C_SCL	Clock line for I <sup>2</sup> C interface. Always implemented, bus type.
13	UART_RX	Receiver line of target device UART
14	UART_TX	Transmitter line of target device UART

Pin number	Name	Description
15	SPI_SS_A	Slave select for SPI. Should preferably be unique.
16	SPI_MOSI	Master out slave in line of serial peripheral interface. Always implemented, bus type.
17	SPI_MISO	Master in slave out line of serial peripheral interface. Always implemented, bus type.
18	SPI_SCK	Clock for serial peripheral interface. Always implemented, bus type.
19	GND	Ground
20	VCC	Power for extension board

### 3.4.2. Xplained Pro Power Header

The power header can be used to connect external power to the SAM D21 Xplained Pro kit. The kit will automatically detect and switch to any external power if supplied. The power header can also be used as supply for external peripherals or extension boards. Care must be taken not to exceed the total current limitation of the on-board regulator when using the 3.3V pin.

**Table 3-5. Xplained Pro Power Header**

Pin number	Pin name	Description
1	VEXT_P5V0	External 5V input
2	GND	Ground
3	VCC_P5V0	Unregulated 5V (output, derived from one of the input sources)
4	VCC_P3V3	Regulated 3.3V (output, used as main power supply for the kit)

## 4. Hardware Users Guide

### 4.1. Connectors

This chapter describes the implementation of the relevant connectors and headers on SAM D21 Xplained Pro and their connection to the ATSAM D21J18A. The tables of connections in this chapter also describes which signals are shared between the headers and on-board functionality.

#### 4.1.1. Xplained Pro Standard Extension Headers

The SAM D21 Xplained Pro headers EXT1, EXT2, and EXT3 offer access to the I/O of the microcontroller in order to expand the board e.g. by connecting extensions to the board. These headers all comply with the standard extension header specified in [Xplained Pro Standard Extension Header](#). All headers have a pitch of 2.54mm.

Table 4-1. Extension Header EXT1

Pin on EXT1	SAM D21 pin	Function	Shared functionality
1 [ID]	-	-	Communication line to ID chip on extension board.
2 [GND]	-	-	GND
3 [ADC(+)]	PB00	AIN[8]	
4 [ADC(-)]	PB01	AIN[9]	
5 [GPIO1]	PB06	GPIO	
6 [GPIO2]	PB07	GPIO	
7 [PWM(+)]	PB02	TC6/WO[0]	
8 [PWM(-)]	PB03	TC6/WO[1]	
9 [IRQ/GPIO]	PB04	EXTINT[4]	
10 [SPI_SS_B/GPIO]	PB05	GPIO	
11 [TWI_SDA]	PA08	SERCOM2 PAD[0] I <sup>2</sup> C SDA	EXT2, EXT3, and EDBG
12 [TWI_SCL]	PA09	SERCOM2 PAD[1] I <sup>2</sup> C SCL	EXT2, EXT3, and EDBG
13 [USART_RX]	PB09	SERCOM4 PAD[1] UART RX <sup>(1)</sup>	
14 [USART_TX]	PB08	SERCOM4 PAD[0] UART TX <sup>(1)</sup>	
15 [SPI_SS_A]	PA05	SERCOM0 PAD[1] SPI SS	
16 [SPI_MOSI]	PA06	SERCOM0 PAD[2] SPI MOSI	
17 [SPI_MISO]	PA04	SERCOM0 PAD[0] SPI MISO	
18 [SPI_SCK]	PA07	SERCOM0 PAD[3] SPI SCK	
19 [GND]	-	-	GND
20 [VCC]	-	-	VCC

**Note:**

1. The SERCOM4 module is shared between EXT1, 2, and 3 UART's, but uses different pins on EXT1 and EXT2/3.

**Table 4-2. Extension Header EXT2**

Pin on EXT2	SAM D21 pin	Function	Shared functionality
1 [ID]	-	-	Communication line to ID chip on extension board.
2 [GND]	-	-	GND
3 [ADC(+)]	PA10	AIN[18]	
4 [ADC(-)]	PA11	AIN[19]	
5 [GPIO1]	PA20	GPIO	
6 [GPIO2]	PA21	GPIO	
7 [PWM(+)]	PB12	TC4/WO[0]	
8 [PWM(-)]	PB13	TC4/WO[1]	
9 [IRQ/GPIO]	PB14	EXTINT[14]	
10 [SPI_SS_B/GPIO]	PB15	GPIO	
11 [TWI_SDA]	PA08	SERCOM2 PAD[0] I <sup>2</sup> C SDA	EXT1, EXT3, and EDBG
12 [TWI_SCL]	PA09	SERCOM2 PAD[1] I <sup>2</sup> C SCL	EXT1, EXT3, and EDBG
13 [USART_RX]	PB11	SERCOM4 PAD[1] UART RX (1)	EXT3
14 [USART_TX]	PB10	SERCOM4 PAD[0] UART TX (1)	EXT3
15 [SPI_SS_A]	PA17	SERCOM1 PAD[1] SPI SS	
16 [SPI_MOSI]	PA18	SERCOM1 PAD[2] SPI MOSI	
17 [SPI_MISO]	PA16	SERCOM1 PAD[0] SPI MISO	
18 [SPI_SCK]	PA19	SERCOM1 PAD[3] SPI SCK	
19 [GND]	-	-	GND
20 [VCC]	-	-	VCC

**Note:**

1. The SERCOM4 module is shared between EXT1, 2, and 3 UART's, but uses different pins on EXT1 and EXT2/3.

**Table 4-3. Extension Header EXT3**

Pin on EXT3	SAM D21 pin	Function	Shared functionality
1 [ID]	-	-	Communication line to ID chip on extension board.
2 [GND]	-	-	GND

Pin on EXT3	SAM D21 pin	Function	Shared functionality
3 [ADC(+)]	PA02	AIN[0]	
4 [ADC(-)]	PA03	AIN[1] <sup>(1)</sup>	USB ID
5 [GPIO1]	PB30	GPIO	Onboard LED0
6 [GPIO2]	PA15	GPIO	Onboard SW0
7 [PWM(+)]	PA12	TCC2/WO[0]	
8 [PWM(-)]	PA13	TCC2/WO[1] <sup>(2)</sup>	Serial Flash SS
9 [IRQ/GPIO]	PA28	EXTINT[8]	
10 [SPI_SS_B/GPIO]	PA27	GPIO	
11 [TWI_SDA]	PA08	SERCOM2 PAD[0] I <sup>2</sup> C SDA	EXT1, EXT2, and EDBG
12 [TWI_SCL]	PA09	SERCOM2 PAD[1] I <sup>2</sup> C SCL	EXT1, EXT2, and EDBG
13 [USART_RX]	PB11	SERCOM4 PAD[1] UART RX <sup>(3)</sup>	
14 [USART_TX]	PB10	SERCOM4 PAD[0] UART TX <sup>(3)</sup>	
15 [SPI_SS_A]	PB17	SERCOM5 PAD[1] SPI SS	
16 [SPI_MOSI]	PB22	SERCOM5 PAD[2] SPI MOSI	EDBG and Serial Flash
17 [SPI_MISO]	PB16	SERCOM5 PAD[0] SPI MISO	EDBG and Serial Flash
18 [SPI_SCK]	PB23	SERCOM5 PAD[3] SPI SCK	EDBG and Serial Flash
19 [GND]	-	-	GND
20 [VCC]	-	-	VCC

**Note:**

1. PA03 can be used by USB ID or EXT3 PIN4 by changing the position of the jumper JS300 on J307.
2. PA13 is by default connected to the Serial Flash SS line and is disconnected from the EXT3 PIN8. This can be changed by moving the 0Ω resistor R314 to R313.
3. The SERCOM4 module is shared between EXT1, 2, and 3 UART's, but uses different pins on EXT1 and EXT2/3.

#### 4.1.2. Current Measurement Header

An angled 1x2, 100mil pin-header marked with MCU current measurement is located at the upper edge of the SAM D21 Xplained Pro. All power to the ATSAMD21J18A is routed through this header. To measure the power consumption of the device remove the jumper and replace it with an ammeter.



**Caution:** Removing the jumper from the pin-header while the kit is powered may cause the ATSAMD21J18A to be powered through its I/O pins. This may cause permanent damage to the device.

## 4.2. Peripherals

### 4.2.1. Crystal

The SAM D21 Xplained Pro kit contains one crystal that can be used as clock source for the SAM D21 device. The crystal has a cut-strap next to it that can be used to measure the oscillator safety factor. This is done by cutting the strap and adding a resistor across the strap. More information about oscillator allowance and safety factor can be found in application note [AVR4100](#).

**Table 4-4. External 32.768kHz Crystals**

Pin on SAM D21	Function
PA00	XIN32
PA01	XOUT32

### 4.2.2. Mechanical Buttons

SAM D21 Xplained Pro contains two mechanical buttons. One button is the RESET button connected to the SAM D21 reset line and the other is a generic user configurable button. When a button is pressed it will drive the I/O line to GND.

**Table 4-5. Mechanical Buttons**

Pin on SAM D21	Silkscreen text
RESETN	RESET
PA15	SW0

### 4.2.3. LED

There is one yellow LED available on the SAM D21 Xplained Pro board that can be turned on and off. The LED can be activated by driving the connected I/O line to GND.

**Table 4-6. LED Connections**

Pin on SAM D21	LED
PB30	Yellow LED0

### 4.2.4. USB

The SAM D21 Xplained Pro has a micro USB receptacle for use with the SAM D21 USB module. To be able to detect when a USB cable is connected, a GPIO is used to detect the VBUS voltage on the connector. The USB ID line is used to detect if a host mode cable is connected and will automatically switch on the power to the USB connector. The I/O connected to USB ID can be used to read the status of the line or manually override the voltage output. For other modes on the USB ID lines, refer to the USB organization specifications.

**Table 4-7. USB Connections**

Pin on SAM D21	USB
PA14	VBUS Detection
PA03	USB ID

Pin on SAM D21	USB
PA24	USB D-
PA25	USB D+

#### 4.2.5. Serial Flash

The SAM D21 Xplained Pro has an onboard 8Mbit serial flash for non-volatile storage of data.

**Table 4-8. Serial Flash Connections**

Pin on SAM D21	Function	Serial Flash	Shared functionality
PA13	GPIO	#CS	EXT3 PIN8 (default disconnected)
PB22	SERCOM5 PAD[2] SPI MOSI	SI	EXT3 and EDBG
PB16	SERCOM5 PAD[0] SPI MISO	SO	EXT3 and EDBG
PB23	SERCOM5 PAD[3] SPI SCK	SCK	EXT3 and EDBG

### 4.3. Embedded Debugger Implementation

SAM D21 Xplained Pro contains an Embedded Debugger (EDBG) that can be used to program and debug the ATSAM D21J18A using Serial Wire Debug (SWD). The Embedded Debugger also include a Virtual Com port interface over UART, an Atmel Data Gateway Interface over SPI and TWI and it monitors four of the SAM D21 GPIOs. Atmel Studio can be used as a front end for the Embedded Debugger.

#### 4.3.1. Serial Wire Debug

The Serial Wire Debug (SWD) use two pins to communicate with the target. For further information on how to use the programming and debugging capabilities of the EDBG, see [Embedded Debugger](#).

**Table 4-9. SWD Connections**

Pin on SAM D21	Function
PA30	SWD clock
PA31	SWD data

#### 4.3.2. Virtual COM Port

The Embedded Debugger acts as a Virtual Com Port gateway by using one of the ATSAM D21J18A UARTs. For further information on how to use the Virtual COM port see [Embedded Debugger](#).

**Table 4-10. Virtual COM Port Connections**

Pin on SAM D21	Function
PA22	SERCOM3 PAD[0] UART TXD (SAM D21 TX line)
PA23	SERCOM3 PAD[1] UART RXD (SAM D21 RX line)

#### 4.3.3. Atmel Data Gateway Interface

The Embedded Debugger features an Atmel Data Gateway Interface (DGI) by using either a SPI or I<sup>2</sup>C port. The DGI can be used to send a variety of data from the SAM D21 to the host PC. For further information on how to use the DGI interface see [Embedded Debugger](#).

**Table 4-11. DGI Interface Connections when using SPI**

Pin on SAM D21	Function
PB31	SERCOM5 PAD[1] SPI SS (Slave select) (SAM D21 is Master)
PB16	SERCOM5 PAD[0] SPI MISO (Master In, Slave Out)
PB22	SERCOM5 PAD[2] SPI MOSI (Master Out, Slave in)
PB23	SERCOM5 PAD[3] SPI SCK (Clock Out)

**Table 4-12. DGI Interface Connections when using I<sup>2</sup>C**

Pin on SAM D21	Function
PA08	SERCOM2 PAD[0] SDA (Data line)
PA09	SERCOM2 PAD[1] SCL (Clock line)

Four GPIO lines are connected to the Embedded Debugger. The EDBG can monitor these lines and time stamp pin value changes. This makes it possible to accurately time stamp events in the SAM D21 application code. For further information on how to configure and use the GPIO monitoring features see [Embedded Debugger](#).

**Table 4-13. GPIO Lines Connected to the EDBG**

Pin on SAM D21	Function
PA27	GPIO0
PA28	GPIO1
PA20	GPIO2
PA21	GPIO3



## 5. Appendix

### 5.1. Getting Started with IAR

IAR Embedded Workbench® for ARM® is a proprietary high efficiency compiler not based on GCC. Programming and debugging of Xplained Pro kits are supported in IAR™ Embedded Workbench for ARM using the common CMSIS-DAP interface. Some initial settings have to be set up in the project to get the programming and debugging to work.

The following steps will explain how to get your project ready for programming and debugging:

1. Make sure you have opened the project you want to configure. Open the **OPTIONS** dialog for the project.
2. In the category **General Options**, select the **Target** tab. [Select the device for the project or, if not listed, the core of the device.](#)
3. In the category **Debugger**, select the **Setup** tab. [Select \*\*CMSIS DAP\*\* as the driver.](#)
4. In the category **Debugger**, select the **Download** tab. [Check the check box for \*\*Use flash loader\(s\)\*\* option.](#)
5. In the category **Debugger > CMSIS DAP**, select the **Setup** tab. [Select \*\*System \(default\)\*\* as the reset method.](#)
6. In the category **Debugger > CMSIS DAP**, select the **JTAG/SWD** tab. [Select \*\*SWD\*\* as the interface and optionally select the \*\*SWD speed\*\*.](#)

Figure 5-1. Select Target Device

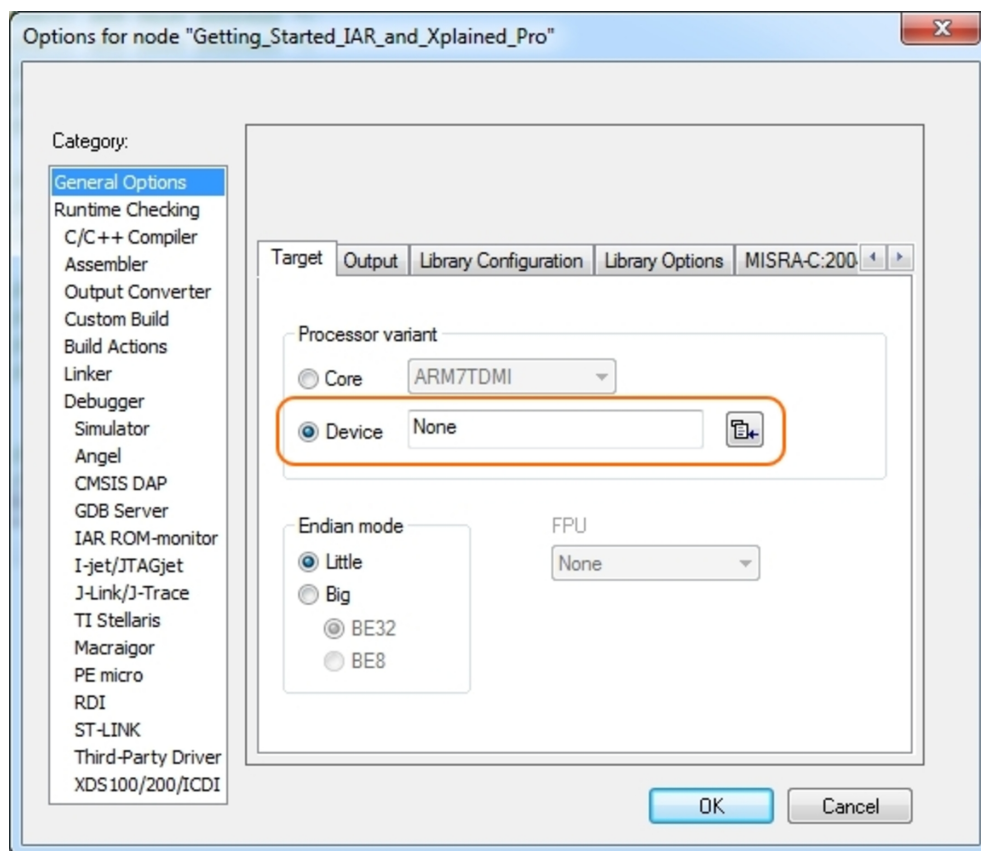

Figure 5-2. Select Debugger

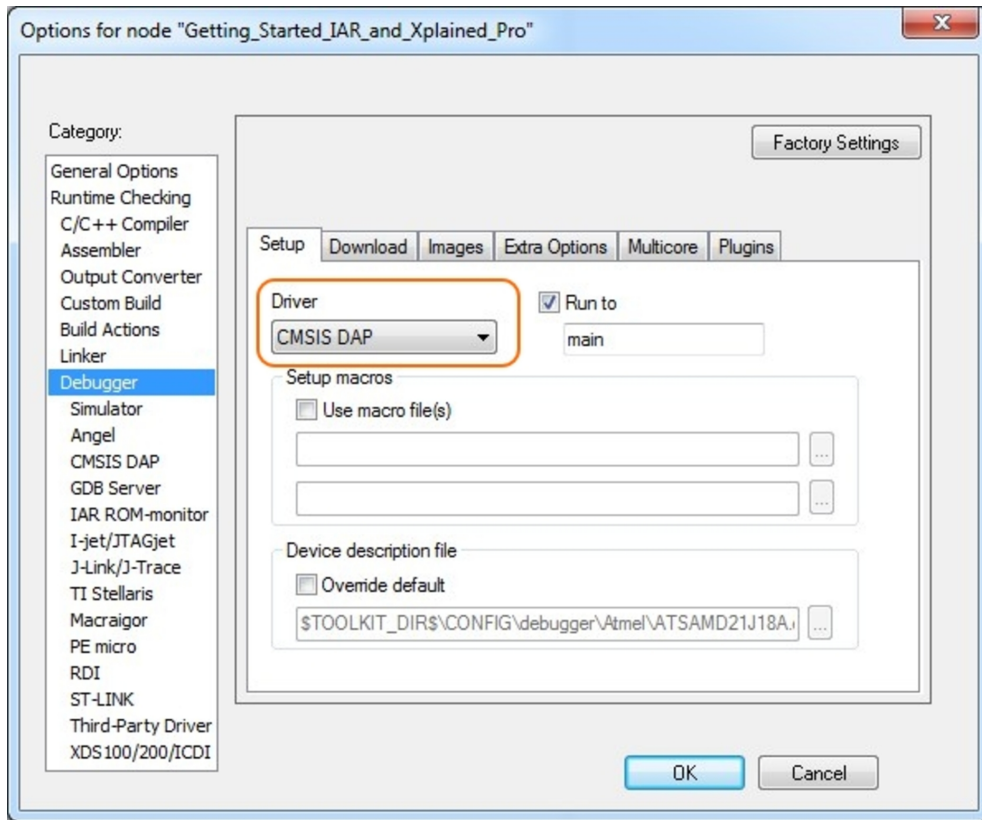

Figure 5-3. Configure Flash Loader

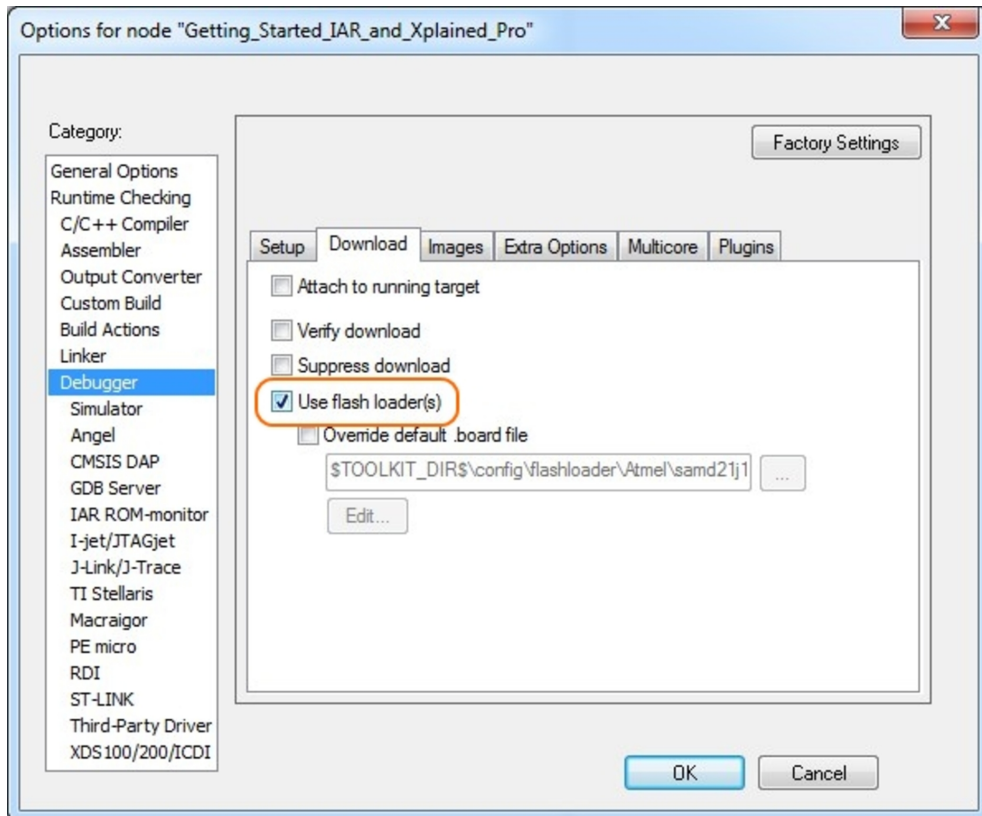

Figure 5-4. Configure Reset

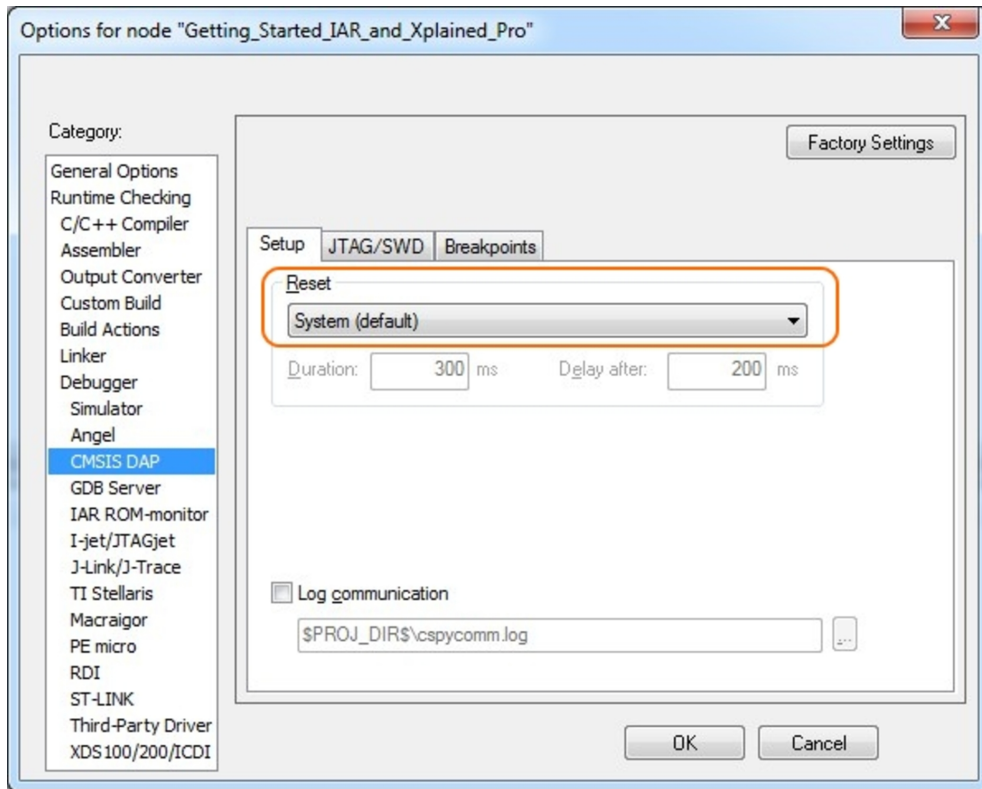
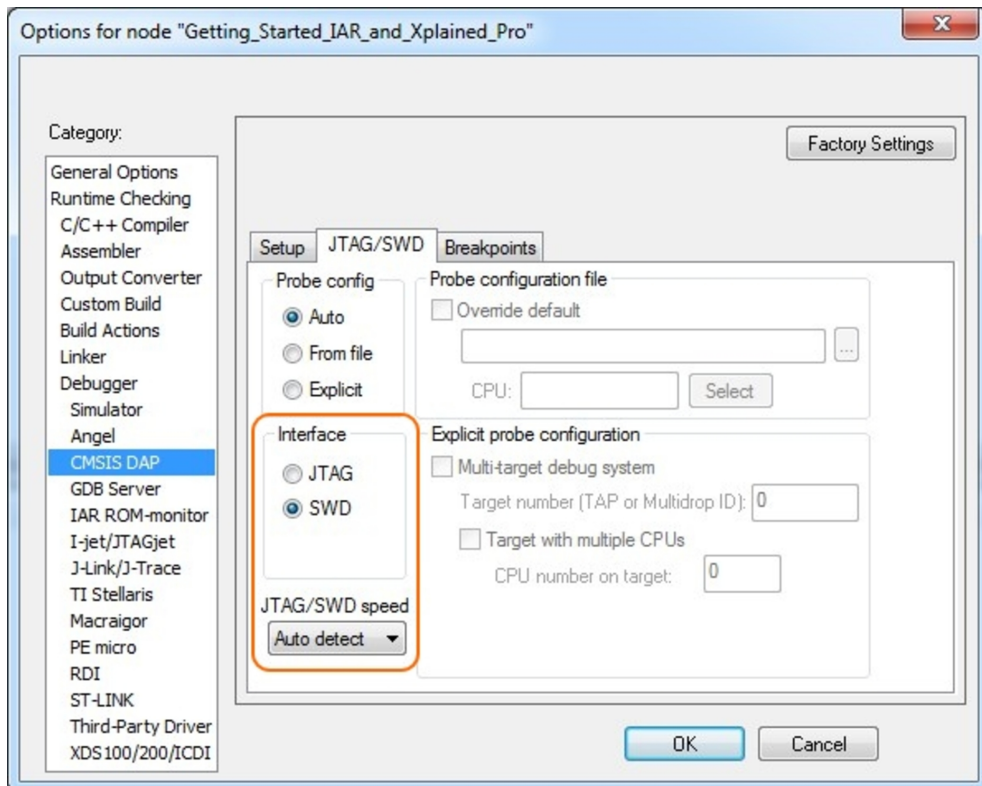

Figure 5-5. Configure Interface



## 6. Hardware Revision and Known Issues

### 6.1. Identifying Product ID and Revision

The revision and product identifier of Xplained Pro boards can be found in two ways; either through Atmel Studio or by looking at the sticker on the bottom side of the PCB.

By connecting an Xplained Pro MCU board to a computer with Atmel Studio running, an information window will pop up. The first six digits of the serial number, which is listed under kit details, contain the product identifier and revision. Information about connected Xplained Pro extension boards will also appear in the Atmel Kit's window.

The same information can be found on the sticker on the bottom side of the PCB. Most kits will print the identifier and revision in plain text as A09-nnnn\rr, where nnnn is the identifier and rr is the revision. Boards with limited space have a sticker with only a QR-code, which contains a serial number string.

The serial number string has the following format:

```
"nnnnrrssssssss"  
n = product identifier  
r = revision  
s = serial number
```

The product identifier for SAM D21 Xplained Pro is A09-2130.

### 6.2. Revision 2

Revision 2 of SAM D21 Xplained Pro is the initial released version.

## 7. Document Revision History

Doc. rev.	Date	Comment
42220B	04/2016	Added <a href="#">Getting Started with IAR.</a>
42220A	02/2014	Initial document release.

## 8. Evaluation Board/Kit Important Notice

This evaluation board/kit is intended for use for **FURTHER ENGINEERING, DEVELOPMENT, DEMONSTRATION, OR EVALUATION PURPOSES ONLY**. It is not a finished product and may not (yet) comply with some or any technical or legal requirements that are applicable to finished products, including, without limitation, directives regarding electromagnetic compatibility, recycling (WEEE), FCC, CE or UL (except as may be otherwise noted on the board/kit). Atmel supplied this board/kit "AS IS", without any warranties, with all faults, at the buyer's and further users' sole risk. The user assumes all responsibility and liability for proper and safe handling of the goods. Further, the user indemnifies Atmel from all claims arising from the handling or use of the goods. Due to the open construction of the product, it is the user's responsibility to take any and all appropriate precautions with regard to electrostatic discharge and any other technical or legal concerns.

EXCEPT TO THE EXTENT OF THE INDEMNITY SET FORTH ABOVE, NEITHER USER NOR ATMEL SHALL BE LIABLE TO EACH OTHER FOR ANY INDIRECT, SPECIAL, INCIDENTAL, OR CONSEQUENTIAL DAMAGES.

No license is granted under any patent right or other intellectual property right of Atmel covering or relating to any machine, process, or combination in which such Atmel products or services might be or are used.

**Mailing Address:**

Atmel Corporation  
1600 Technology Drive  
San Jose, CA 95110  
USA



**Atmel®** | Enabling Unlimited Possibilities®



**Atmel Corporation**    1600 Technology Drive, San Jose, CA 95110 USA    **T:** (+1)(408) 441.0311    **F:** (+1)(408) 436.4200    |    **www.atmel.com**

© 2016 Atmel Corporation. / Rev.: Atmel-42220B-SAM-D21-Xplained-Pro\_User Guide-04/2016

Atmel®, Atmel logo and combinations thereof, Enabling Unlimited Possibilities®, AVR®, QTouch®, and others are registered trademarks or trademarks of Atmel Corporation in U.S. and other countries. Windows® is a registered trademark of Microsoft Corporation in U.S. and other countries. ARM®, ARM Connected® logo and others are the registered trademarks or trademarks of ARM Ltd. Other terms and product names may be trademarks of others.

**DISCLAIMER:** The information in this document is provided in connection with Atmel products. No license, express or implied, by estoppel or otherwise, to any intellectual property right is granted by this document or in connection with the sale of Atmel products. EXCEPT AS SET FORTH IN THE ATMEL TERMS AND CONDITIONS OF SALES LOCATED ON THE ATMEL WEBSITE, ATMEL ASSUMES NO LIABILITY WHATSOEVER AND DISCLAIMS ANY EXPRESS, IMPLIED OR STATUTORY WARRANTY RELATING TO ITS PRODUCTS INCLUDING, BUT NOT LIMITED TO, THE IMPLIED WARRANTY OF MERCHANTABILITY, FITNESS FOR A PARTICULAR PURPOSE, OR NON-INFRINGEMENT. IN NO EVENT SHALL ATMEL BE LIABLE FOR ANY DIRECT, INDIRECT, CONSEQUENTIAL, PUNITIVE, SPECIAL OR INCIDENTAL DAMAGES (INCLUDING, WITHOUT LIMITATION, DAMAGES FOR LOSS AND PROFITS, BUSINESS INTERRUPTION, OR LOSS OF INFORMATION) ARISING OUT OF THE USE OR INABILITY TO USE THIS DOCUMENT, EVEN IF ATMEL HAS BEEN ADVISED OF THE POSSIBILITY OF SUCH DAMAGES. Atmel makes no representations or warranties with respect to the accuracy or completeness of the contents of this document and reserves the right to make changes to specifications and products descriptions at any time without notice. Atmel does not make any commitment to update the information contained herein. Unless specifically provided otherwise, Atmel products are not suitable for, and shall not be used in, automotive applications. Atmel products are not intended, authorized, or warranted for use as components in applications intended to support or sustain life.

**SAFETY-CRITICAL, MILITARY, AND AUTOMOTIVE APPLICATIONS DISCLAIMER:** Atmel products are not designed for and will not be used in connection with any applications where the failure of such products would reasonably be expected to result in significant personal injury or death ("Safety-Critical Applications") without an Atmel officer's specific written consent. Safety-Critical Applications include, without limitation, life support devices and systems, equipment or systems for the operation of nuclear facilities and weapons systems. Atmel products are not designed nor intended for use in military or aerospace applications or environments unless specifically designated by Atmel as military-grade. Atmel products are not designed nor intended for use in automotive applications unless specifically designated by Atmel as automotive-grade.

# Mouser Electronics

Authorized Distributor

Click to View Pricing, Inventory, Delivery & Lifecycle Information:

[Atmel:](#)

[ATSAMD21-XPRO](#)